

Hardware Manual

TSD350-10, TSD350-15, Revision 2



Keep all manuals belonging to this product during its life span. Pass all manuals to future owners and users of this product. This English version is the original version of the product manual.

Document HWTSD350_2_HardwareManual_EP
Version 004, 2024-04-18
Source Q:\Doc\Hardware\HWTSD\TSD350\HWTSD350_HardwareManual\
Destination T:\doc\Hardware
Owner ab

Table of Contents

- 1 General.....5
 - 1.1 Target Group.....5
 - 1.2 Standards Used.....6
 - 1.3 Symbols Used.....6

- 2 Safety.....7
 - 2.1 Intended Use.....8
 - 2.1.1 Cabinet.....8
 - 2.1.2 Power Supply.....8
 - 2.1.3 Motors.....8
 - 2.1.4 Safety.....8
 - 2.2 Prohibited Use.....8
 - 2.3 Responsibility.....9
 - 2.4 EC Declaration of Conformity.....9

- 3 Nomenclature.....10
 - 3.1 Order Key Codes.....10
 - 3.1.1 DCV.....10
 - 3.1.2 A_{RMS}.....10
 - 3.1.3 Fieldbus.....10
 - 3.1.4 Commutation Speed.....11
 - 3.1.5 Option Modules.....11
 - 3.2 Accessories.....11

- 4 Handling.....12
 - 4.1 Nameplate.....12
 - 4.2 Transport.....12
 - 4.3 Storage.....13
 - 4.4 Packaging.....13
 - 4.5 Disassembling.....14
 - 4.6 Maintenance, Cleaning and Repair.....14
 - 4.6.1 Cleaning.....14
 - 4.6.2 Repair.....14
 - 4.7 Disposal.....14

- 5 Technical Description.....15
 - 5.1 Features.....15
 - 5.1.1 General.....15
 - 5.1.2 Supervision.....15
 - 5.1.3 Commissioning and Diagnostics.....15
 - 5.1.4 Communication.....15

5.1.5	In-Drive TAMA Programming.....	16
5.1.6	PC Programming.....	16
5.2	Electrical Specifications.....	17
5.2.1	Drive.....	17
5.2.2	Rated Currents.....	18
5.3	EMC and Motor Properties.....	19
5.3.1	Protective Earthing Conductor Current.....	19
5.4	Motor Brake.....	20
5.5	Dynamic Braking.....	20
5.6	Safety Function STO.....	21
5.6.1	Typical Use.....	21
5.6.2	Commissioning.....	21
5.6.3	Functional Description.....	21
5.6.4	Safety Characteristic Data.....	23
5.6.5	Prohibited Use.....	23
5.7	Commutation Frequency Limitation.....	24
5.7.1	Rotational Motor.....	24
5.7.2	Linear Motor.....	24
5.7.3	DC Motor.....	24
5.8	Mechanical Specifications.....	25
5.9	Ambient and Mounting Conditions.....	25
6	Mechanical Installation.....	26
6.1	Safety Instructions.....	26
6.2	Guide to Mechanical Installation.....	27
6.2.1	Site.....	27
6.2.2	Cooling.....	27
6.2.3	Mounting.....	27
7	Electrical Installation.....	28
7.1	Safety Instructions.....	28
7.2	Guide to Electrical Installation.....	29
7.2.1	Connectors and Cables.....	29
7.2.2	Grounding.....	29
7.2.3	Wiring and Shielding.....	29
7.2.4	Final Check.....	29
7.3	Overview of Servo Drive Connections.....	30
7.4	Connectors and Terminals.....	31
7.5	Electrical Supplies (X1, X2).....	32
7.5.1	DC-Bus (X1).....	32
7.5.2	24V Logic Supply (X2).....	34
7.6	Safe Function Outputs (X3).....	35
7.7	Safe Torque Off STO (X4).....	36

- 7.8 Fieldbus Connection (X5, X6).....37
 - 7.8.1 Tria-Link.....37
 - 7.8.2 EtherCAT.....37
- 7.9 Option Modules (X10, X11).....38
- 7.10 Encoder (X20, X21).....39
 - 7.10.1 Analog sin/cos Encoder with Index.....40
 - 7.10.2 Digital Encoder with sin/cos Signals.....41
 - 7.10.3 Digital Encoder without sin/cos Signals.....42
 - 7.10.4 Incremental RS422 Encoder with Index.....43
 - 7.10.5 Incremental RS422 Fast Encoder with Index.....44
 - 7.10.6 Incremental TTL Encoder with Index.....45
 - 7.10.7 TTL Inputs Connection.....46
- 7.11 Digital Inputs and Outputs (X30, X31).....47
 - 7.11.1 Digital Inputs.....47
 - 7.11.2 Digital Outputs.....48
- 7.12 Motor Connection (X40, X41).....49
 - 7.12.1 Motor Power Connection.....49
 - 7.12.2 Motor Temperature.....51
 - 7.12.3 Motor Brake.....52
- 8 Commissioning and Diagnostics.....53
 - 8.1 Status Indicators.....53
 - 8.1.1 System Status Indicator.....54
 - 8.1.2 STO Status.....54
 - 8.1.3 Run and Error Link Status.....55
 - 8.1.4 Axis Status Indicator.....55
- 9 Appendix.....56
 - 9.1 Warranty Information.....56
 - 9.2 Service.....56
- References.....57
- Glossary.....58
- Revision History.....59



During operation there are hazards, with the possibility of death, serious injury or material damage. The operator must ensure that the safety instructions in this manual are followed and that all personnel responsible for working with the drive have read and understood the product manual.

1 General

Dear user!

This manual describes the *TSD350* series of *Triamec* servo drives. In order to start operation of your drive quickly and without problems, read this manual before carrying out any operation with the Triamec hardware.

Technical data, dimensional drawings and more information can be found at www.triamec.com.

1.1 Target Group

This manual addresses persons with the following qualifications:

Transport: Only persons which know how to handle electrostatically sensitive components.

Installation: Only electrically qualified personnel.



Setup: Only persons with electrical engineering and servo drive technology qualifications.
The qualified personnel must know and observe the following standards:
IEC 60364 and IEC 60664 national accident prevention regulations.

1.2 Standards Used

Standard	Content
EN ISO 13849-1:2015	Safety of machinery: Safety-related parts of control systems
IEC 60204	Safety of machinery: Electrical equipment of machines
IEC 60364	Low-voltage electrical installations
EN 60529:1989	Degrees of protection provided by enclosures (IP Code)
IEC 60664-1:2020	Insulation coordination for equipment within low-voltage systems
IEC 60721-3-2:2018 IEC 60721-3-3:2019	Classification of environmental conditions
IEC 61326-3-1:2017	Immunity Requirements for safety-related systems
IEC 61508:2010	Functional safety of electrical/ electronic/ programmable electronic safety-related systems
IEC 61800 EN 61800-1:2018 EN 61800-3:2019 EN 61800-5-1:2017 EN 61800-5-2:2017	Adjustable speed electrical power servo drive systems General Requirements EMC requirements and specific test methods Safety requirements – Electrical, thermal and energy Functional Safety

1.3 Symbols Used







The following table lists the symbols that are used in this manual. Each symbol belongs to its danger class with the risk which arises when not complying the safety instruction.

Symbol	Indication
	DANGER CAUSED BY HIGH VOLTAGE OR HIGH CURRENT! Indicates an electrical hazard situation which will result in death or serious injury, if not avoided!
	DANGER CAUSED BY ROTATING OR MOVING PARTS! Indicates a hazard situation which could result in death or serious injury, if not avoided!
	ATTENTION! Indicates a hazard situation which could result in minor or moderate injury or may cause damage to or malfunction of the hardware, if not avoided!

Notice: Indicates useful information or a reference to another document

2 Safety

- Notice:** The user must have read and understood this manual before carrying out any operation on *Triamec* hardware. The safety information must be observed every time to avoid hazards and/or material damage. *Triamec Motion AG* disclaims all responsibility to possible industrial accidents and material damages if the procedures & safety instructions described in this manual are not followed.
- Notice:** Check the Hardware Revision Number of the product. This revision number must match the Hardware Revision Number on the cover page of this manual. Always comply with the connection conditions and technical specifications.
- Notice:** Do not touch electronic components and contacts of the servo drive (electrostatic discharge may destroy components). Discharge your body before touching the servo drive.
- Notice:** Please contact *Triamec Motion AG* in case of missing information or doubt regarding the installation procedures, safety or any other issue.

Safety Information	
	During operation there are hazards, with the possibility of death, serious injury or material damage. Do not open or touch the equipment during operation. Keep all covers and cabinet doors closed during operation. Touching the equipment is allowed during installation and commissioning for properly qualified persons only.
	There is a danger of electrical arcing to electrical contacts or persons. To avoid electric arcing, never touch contacts of the servo drive or connect/disconnect the servo drive while it is operating and the power source is on.
	Contacts and cables can carry a high voltage, even when the motor is not in motion. Disconnect the servo drive from all voltage sources before it is disassembled for servicing. After shutting off the power and disconnecting the servo drive from the power lines, wait at least ten minutes before touching parts of the equipment that are normally loaded with electrical charges. Capacitors can still have dangerous voltages present up to ten minutes after switching off the power. To be sure, measure the voltage of the DC Bus and wait until the voltage is below 40V.
	Only properly qualified personnel are permitted to carry out activities such as transport, installation, commissioning and maintenance. Properly qualified persons are those who are familiar with the transport, assembly, installation, commissioning and operation of the product, and who have the appropriate qualifications for their job. The qualified personnel must know and observe the following standards: <ul style="list-style-type: none"> • IEC 60364 and IEC 60664 • national accident prevention regulations
	The manufacturer of the machine must produce a risk assessment for the machine and take appropriate measures to ensure that unforeseen movements do not result in personal injury or material damage.
	Servo drives may have hot surfaces during operation and some time after switching off. The Surface can reach temperatures above 80°C. Touching the surface can lead to personal injury.

2.1 Intended Use

Servo drives are safety components for installation into stationary electric, industrial machines and commercial systems.

Safety Information	
	<p>The manufacturer of the machine must produce a risk assessment for the machine and take appropriate measures to ensure that unforeseen movements do not result in personal injury or material damage.</p>

2.1.1 Cabinet

The servo drive must only be operated in a closed control cabinet, as defined in chapter 5.9, which may also require ventilation or cooling.

2.1.2 Power Supply

The servo drive must be connected to a compatible power supply. Possible devices are *Triamec TP350* for the *TSD350* servo drives. Connection to power supplies is described in chapter 7.5.1.

2.1.3 Motors

The *TSD350* family of servo drives is exclusively intended for driving suitable synchronous servomotors, asynchronous motors, voice coil and DC motors.

2.1.4 Safety

Observe the chapter 5.6 when you use the safety function STO.

2.2 Prohibited Use

Other use than described in chapter 2.1 is not intended and can lead to injured persons or damage of equipment. The use of the servo drive in the following environments is prohibited:

- potentially explosive areas (ATEX)
- environments with corrosive and/or electrically conductive acids, alkaline solutions, oils, vapors, dusts

Commissioning the servo drive is prohibited if the machine in which it was installed,

- does not meet the requirements of the EC Machinery Directive
- does not comply with the EMC Directive or with the Low Voltage Directive
- does not comply with any national directives

The control of holding brakes by these servo drives alone may not be used in applications, where personnel security is to be ensured with the brake.

2.3 Responsibility

Electronic devices are never fail-safe. The company setting up and/or operating the machine or plant is itself responsible for ensuring that the servo drive is rendered safe if the device fails.

The standard IEC 61800-5-2 'Safety of machines' stipulates safety requirements for electrical controls. They are intended for the safety of personnel and machinery as well as for maintaining the functional capability of the machine or plant concerned, and must be observed.

The function of an emergency stop system does not necessarily cut the power supply to the drive. To protect against danger, it may be more beneficial to keep individual servo drives running or to initiate specific safety sequences.

2.4 EC Declaration of Conformity

Triamec Motion AG provides EC declarations of conformity upon request to info@triamec.com.

Notice: This product can cause high-frequency interference in non industrial environments. This can require measures for interference suppression like additional external EMC filters.

Conformance with the IEC 61800 is mandatory for the supply of servo drives within the European Community.

The servo drive meets the noise immunity requirements to the 2nd environmental category (industrial environment). For noise emission the servo drive meets the requirement to a product of the category C2 under certain conditions. More information can be found in chapter 5.3.

3 Nomenclature

Series	DCV	-	A_{RMS}	-	Variants (Fieldbus, Speed)	[-	Option Modules (Axis 0, Axis 1)	[-	SW Options (Option 1, Option 2)]]
TSD	350	-	10	-	EH	-	ENFF	-	GYXC	

Table 1: Example part number of a TSD350-10-EH-ENFF-GYXC dual-axis servo drive with 350V nominal voltage, 10Arms per axis and EtherCAT fieldbus, supporting electrical commutation frequencies $\geq 600\text{Hz}$. It has an additional encoder module on extension slot 0 and a fast Fourier transform module on slot 1. The servo drive further includes the software options for gantry stage control and eccentricity compensation.

Decide from the following product variants when ordering a TSD family servo drive. The “D” in the family name denotes dual axis servo drives capable of driving two motors.

The first number (DCV) after the family name is the nominal DC-bus voltage rating. This manual covers the 350V product. The 350V product is available in 10Arms and 15Arms versions.

All available products and variants with order key codes are listed on the website www.triamec.com.

3.1 Order Key Codes

3.1.1 DCV

Code	Description
350	Nominal DC-bus voltage

3.1.2 A_{RMS}

Code	Description
10	Maximum rated output current of $10A_{RMS}$
15	Maximum rated output current of $15A_{RMS}$

3.1.3 Fieldbus

Code	Description
E	EtherCAT
T	Tria-Link

3.1.4 Commutation Speed

Code	Description
L	Simplified Export. A servo drive with this option supports electrical commutation frequencies which are fewer than 600Hz.
H	High Speed. A servo drive with this option supports electrical commutation frequencies which are equal or higher than 600Hz and is subject to export restrictions in some countries.

3.1.5 Option Modules

For more information on the different option modules, see [5]. The order number can be found as the first two letters in the title of the corresponding module.

3.2 Accessories

Triamec Motion AG delivers some useful accessories for the servo drives. The table below shows the most helpful items. For more information contact Triamec Motion AG or visit the Triamec homepage www.triamec.com.

	Product	Specification
Power Supply	TP350	Input Voltage: 1x or 3x44...230V _{AC} ±10%, 50/60Hz Output Voltage: rated 325VDC
Servo Drive Accessories	STO-plug assembly	If STO is not to be used
	Motor-shield/screen management	Triamec shield connection clamp

4 Handling

4.1 Nameplate

The nameplate depicted below is attached to the side of the servo drive.



Figure 1: Nameplate of the TSD series servo drives

4.2 Transport

- During transport, the servo drive must remain inside its original packaging which complies with the ESD standard.
- The transport conditions must respect the IEC 61800-1 standard.
- Transport by qualified personnel only.
- Avoid shocks while transporting.
- The servo drives contain electrostatic sensitive components, that can be damaged by incorrect handling. Discharge yourself before touching the servo drive. Avoid contact with highly insulating materials, such as artificial fabrics and plastic films. Place the servo drive on a conductive surface.
- If the packaging is damaged, check the unit for visible damage. In such an event, inform the shipper and the manufacturer.

TSD350													
Temperature	-25°C (-13°F) and +70°C (+158°C), max. rate of change 20K / hour												
Humidity	less than 95% at max +40°C without condensation												
Shock limit	Dropping height of packed device max. 0.25m												
	<table border="1"> <thead> <tr> <th>Frequency</th> <th>Amplitude</th> <th>Acceleration</th> </tr> </thead> <tbody> <tr> <td>2Hz ≤ f < 9Hz</td> <td>3.5mm</td> <td>not applicable</td> </tr> <tr> <td>9Hz ≤ f < 200Hz</td> <td>not applicable</td> <td>10m/s²</td> </tr> <tr> <td>200Hz ≤ f < 500Hz</td> <td>Not applicable</td> <td>15m/s²</td> </tr> </tbody> </table>	Frequency	Amplitude	Acceleration	2Hz ≤ f < 9Hz	3.5mm	not applicable	9Hz ≤ f < 200Hz	not applicable	10m/s ²	200Hz ≤ f < 500Hz	Not applicable	15m/s ²
Frequency	Amplitude	Acceleration											
2Hz ≤ f < 9Hz	3.5mm	not applicable											
9Hz ≤ f < 200Hz	not applicable	10m/s ²											
200Hz ≤ f < 500Hz	Not applicable	15m/s ²											

4.3 Storage

- During storage, the servo drive must remain inside its original packaging which complies with the ESD standard.
- The storage conditions must respect the IEC 61800-1 standard.

TSD350	
Temperature	-25°C (-13°F) and +55°C (+131°F), max. rate of change 20K / hour
Humidity	between 5 and 95% without condensation
Storage duration	Less than 2 years: without restriction. More than 2 years: capacitors must be reformed before setting up and operating the drive. To do this, remove all electrical connections and apply DC for about 30 minutes to the DC-Bus terminals (X1).



4.4 Packaging

Triamec servo drives come in a recyclable cardboard box with the following content.

TSD350	
Dimensions W x D x H	320 x 240 x 80mm ³
Labeling	label on box
Delivery content	<ul style="list-style-type: none"> ▪ Servo drive <i>TSD350</i> ▪ Mating connectors X1, X2, X4, X30, X31, X40, X41 ▪ Further documentation and installation software are available on the company website.

4.5 Disassembling

Observe the sequence below, if a servo drive has to be disassembled (e.g. for replacement).

	Action
	1. Switch off the power supply that supplies the drive. Wait at least ten minutes after switching off the power supply before touching potentially live sections of the equipment (e.g. contacts). To be sure, measure the voltage of the DC Bus and wait until it has fallen below 40V. Remove the wiring. Disconnect the earth (ground) connection at last.
	2. During operation the heat sink of the servo drive may reach high temperatures. Before touching the device, check the temperature and wait until it has cooled down below 40°C (104°F).

4.6 Maintenance, Cleaning and Repair

The devices do not require any maintenance, opening the devices invalidates warranty.

4.6.1 Cleaning

If the casing is dirty, clean with Isopropanol or similar. Do not immerse or spray. Dirt inside the unit must be cleaned by the manufacturer.

4.6.2 Repair

Repair of the servo drive must be done by the manufacturer. Opening the devices means loss of the guarantee. Disassemble the equipment as described in chapter 4.5 and send it in the original packaging to Triamec Motion AG.

4.7 Disposal

We take old devices and accessories back for professional disposal (WEEE-2002/96/EC-Guidelines). Transport costs are the responsibility of the sender. Disassemble the equipment as described in chapter 4.5 and send it to Triamec Motion AG.

5 Technical Description

The Triamec digital servo drives *TSD350* series master even the most difficult motion problems: Highly dynamic positioning tasks or on the other hand very precise motion.

This series is available for two fieldbuses, *Tria-Link* a flexible fieldbus developed by Triamec, and *Ether-CAT*, a standardized fieldbus.

The drives are equipped with state of the art dual core cortex-A53 and FPGA technology that allows controller sampling rates up to 100kHz. They do not include an integral power supply. The corresponding power supply *TP350* is ordered separately from Triamec Motion AG.

5.1 Features

5.1.1 General

- Two motor axis systems per servo drive.
- Standard two full featured encoder inputs, additional inputs possible with option modules.
- sin/cos-Encoder with auto-calibration, Incremental- or Digital Encoder supported.
- Up to two option modules for additional encoders, analog inputs, and more.
- 100kHz current controller loop with space vector modulation and an advanced feed forward path.
- 100kHz position controller loop with dual PID architecture and 2*5 filter blocks per axis.
- 10kHz internal path planning re-programmable at 10kHz.
- External path planning at 10 kHz (axis coupling)
- Support for synchronous servomotors, asynchronous motors and direct current motors.
- Stand-alone mode, persistent parameters and program code.
- Compact dimensions

5.1.2 Supervision

- i²t motor and drive, over-voltage, over-current protection.
- Safety function STO (up to SIL 3, PLe)

5.1.3 Commissioning and Diagnostics

- *TAM System Explorer* via *USB*, *Ethernet* or *Tria-Link*: servo drive commissioning and real time scope (80 signals at 10kHz or 8 at 100kHz).

5.1.4 Communication

- Stand-alone operation

- *Tria-Link* fieldbus with host (PC) by PCI-/PCI-Express card *TLxxx* and inter servo drive communication with up to 200Mbps.
- *EtherCAT* servo drives with standard *EtherCAT COE* slave, may be used as DC-master function.

5.1.5 In-Drive TAMA Programming

- 100µs reaction time
- Virtual Machine (TAMA) that executes freely programmable code
- Programming language (Microsoft® C#)
- 1 real-time user program in 10kHz task
- 1 axis coupling program in 10kHz
- 1 asynchronous user program
- Stand-alone applications possible

5.1.6 PC Programming

- Control Application on Windows PC via TAM API for Microsoft® .NET Framework
- Control Application on Beckhoff TwinCAT PLC with CNC or NCI
- Control Application on Linux PC via C++ Kernel driver

5.2 Electrical Specifications

5.2.1 Drive

		TSD350-10	TSD350-15	Units
DC-Bus voltage nominal		350		V _{DC}
DC-Bus voltage range ¹		24 - 400		V _{DC}
Motor Configuration		AC 2 or 3 phase synchronous or asynchronous, DC		-
Min. Motor Inductance		100		μH
Current Continuous	50 kHz	10	15	A _{RMS}
	100 kHz	7.5	11.25	A _{RMS}
Current Peak	50 kHz	20	30	A _{PK}
	100 kHz	15	22.5	A _{PK}
Peak Current Duration ²		2		s
Switching Frequency		50 or 100		kHz
Output Power Continuous (at 50kHz)		4600	6900	W
Logic Supply (PELV)	Voltage	24		V _{DC}
	Max. Current	1.6	1.8	A
Temperature Supervision		Various sensors in the servo drive (temperature range -40°C ... 125°C), one external sensor per motor, supported sensor types: KTY83, KTY84, PT100, PT1000, PTC-1K (temperature range -40°C ... 300°C)		-
Position Encoder	General	The supply delivers 5.2V and maximum 250mA and is short-circuit proof. It is connected to internal 24V and requires enforced insulation against the motor phases.		-
	Analog	sin/cos 1Vs, 65536 times interpolation, auto calibration, FIR-Filtering, max. frequency 500kHz (option EH: 2MHz 18bit / 10MHz quadrature).		-
	Incremental	Glitch- and FIR-Filtering; Standards: RS-422 or TTL, RS422: max. pulse-frequency 500kHz (RS422 Fast: 10MHz), TTL: max. pulse-frequency 2.5MHz		-
	Digital	Standards: EnDat 2.1/2.2, BiSS B and BiSS C absolute pos. with analog sin/cos and EnDat 2.2, BiSS B and BiSS C, Tamagawa and Nikon without analog sin/cos.		-

¹ Absolute maximum ratings.

² The servo drive continuously calculates a thermal model i^2t for the three motor phases and for the three servo drive phases and switches off before damage can occur.

	TSD350-10	TSD350-15	Units
Digital Inputs	6 Inputs per axis, isolated from the logic supply, 24V, In1&2(300µs), In3..6(1200µs), Inputs according to IEC EN61131-2, Type 1 with typical currents of 7mA@24V. One fast input at Axis0DigIn1(200ns).		-
Digital Inputs TTL	Up to 4 high speed inputs per axis (200ns), 3.3V TTL, located on the encoder connectors.		-
Digital Outputs	2 isolated high-side switches per axis, 24V, 1A continuous. The common ground of all outputs is galvanically isolated from the logic supply. An external supply must be provided, which may be the logic supply. Max. 3.7A continuous for all 4 outputs together. Turn-On time: Typical: 100us max. 250us; Turn-Off time: Typical: 100us max. 270us		-
Safe Digital Input 7	1 input, galvanically connected to STO common ground, 24V, In7(1200us). Input according to IEC EN61131-2, Type 1 with typical currents of 7mA@24V.		-
Safe Function Outputs	6 safe outputs, high-side switches, 24V, 50mA. The common ground of the outputs is the 24V Logic supply ground at X2.		-
Safe Torque Off (STO)	<p>STO inputs 1 and 2, fully isolated, 24V, inputs according to IEC EN61131-2, Type 1 with typical currents of 7mA@24V.</p> <p>The safe OFF-State is entered latest below $U_{Safe}^{STO} = 5V$.</p> <p>The reliable ON-State is reached above 15V.</p> <p>Process-safety time $t_{Safe}^{STO} = 50ms$, STO-inconsistent time $t_{Inconsistent}^{STO} = 50ms$</p> <p>STO-ignore time $t_{Ignore}^{STO} = 1ms$, STO-ignore rate $f_{Ignore}^{STO} = 1Hz$</p> <p>The STO Aux 24V output and Gnd of X4 must only be used for bridging to STO Ch1 and Ch2 of X4 when STO is not used. (see chapter 7.7)</p>		-

5.2.2 Rated Currents

The maximum permissible servo drive output current and the peak current are dependent on the power stage switching frequency, the servo drive type and the ambient temperature.

All the specifications in the table above are given for an ambient temperature ranging from +5°C (41°F) to +40°C (104°F).

Overload protection on the supply side: The TPxxx power supply hardware manual demands a three phase input current protection of 20A and a maximum prospective current rating of 40 kArms. Equivalent protection must be provided, if a third party power supply is used.

5.3 EMC and Motor Properties

There are restrictions on the motor and motor cable properties depending on the PWM frequency. In the following table, capacity refers to the sum of cable capacity and motor capacity with respect to earth.

	100 kHz PWM	50 kHz PWM	Unit
Capacity per axis	10	5	nF

The Hardware Manual of the power supply *TP350* contain

- Further restrictions on the total permissible capacity of all motors and motor cables attached to the same power supply.
- The expected EMC class according to the standard EN 61800-3 depending on these properties.

To reach these EMC requirements, proper shielding is mandatory, see chapter 7.2. Some motor properties might require a motor-side differential and common mode filtering. The main purpose of the differential (sine) filter is the reduction of motor ripple currents. The common mode filter on the other side works against currents through the motor bearings or through the attached tools like milling cutters.

If a third party power supply is used, be aware that

- The EMC level reached depends strongly on the common mode filter capability of the power supply.
- The complete system must be tested for conformance with 61800-3, especially the conducted emissions part.
- Input protection circuitry must protect the DC-Bus from external Burst and Surge events.

Safety Information	
 WARNING	For insulation or voltage tests, all Triamec servo drives must be disconnected!



Notice: For more information regarding recommended grounding and shielding instructions, refer to Application Note [7].

5.3.1 Protective Earthing Conductor Current

There are two 22nF Y-capacitors between each DC-Bus line and earth. These cause currents in the protective earth connections, if the DC-Bus contains common mode components of the line frequency. The same applies due to the motor shielding capacitors 5.3, when the motor PWM is on. These currents may extend beyond the 3.5mAAC limit of the 61800-5-1:2008 standard. Therefore a second earth connection is mandatory, see chapter 7.5.1.

5.4 Motor Brake

A motor holding brake can be controlled directly by the servo drive. The digital output 1 or 2 switch is used for the brake functionality. See brake wiring in chapter 7.12.3. Consult [2] for the software configuration of the motor brake.

Symbol	Safety Information
	<p>AVOID DANGER ON POSSIBLE FAILURE</p> <p>Be aware that this is not a safety output. It is prohibited to use this output alone when failure might cause a dangerous situation.</p>
	<p>This function does not ensure personnel safety! Hanging loads (vertical axes) require an additional mechanical brake which must be safely operated or series connection of the safety switch in within the brake loop shown here.</p>

Notice: A safe brake output is provided but not certified yet.

5.5 Dynamic Braking

During braking with the aid of the motor, energy is fed back to the servo drive system and the voltage of the DC-Bus may increase. Using the Triamec *TP350* supports this situation with the brake resistor in the Power supply.

Using the Triamec *TP350* power supply, several servo drives of the same series can be operated on a common DC bus link, without requiring any additional measures. Energy fed back by one servo drive is stored in the power supply capacitors. If the voltage passes the brake limit of the power supply, the internal or external brake resistor dissipates energy. If the energy to be dissipated goes beyond the brake resistor specification, this feature is turned off and the bridge voltage rises further. Then the maximum bridge voltage of the servo drives will be reached and the servo drives generate the error *DCBus-VoltageOutOfRange* and the output stage is switched off. Since the mechanics now runs without deceleration, the bridge voltage will not rise any further.

For more information see the documentation of the *TP350* Power Supply [1].

5.6 Safety Function STO

The Safe-Torque-Off (STO) feature protects personnel against unintended restarting of servo drives. See chapter 7.7 for connector description.

5.6.1 Typical Use

A typical use case of the STO function is the integration in the safety concept of a CNC machine. The door of the critical area contains a safety switch attached to a safety device. If the door is opened, the safety device opens two relay contacts. These are wired to the STO function of the drive. With the contacts open, the two channels of the STO cut the energy to the motor leaving the servo drive in a safe state.

5.6.2 Commissioning

Before using the *STO* safety features execute a risk assessment of the equipment to confirm that the system safety conditions are met.

The following actions need to be taken during installation before using the STO safety features.

- Make sure the *STO* channels are connected to the external safety switch as defined during parent system design.
- Setup the servo drives and start communication. Enable the axis. Make sure there is no error message.
- Disconnect one *STO* channel from the Safety switch and check the servo drive state. The state must show a *STO inconsistent error*.
- Connect both channels as standard, clear the error from above and Enable the axis again.
- Disconnect both channels simultaneously. The state must show *STO Active Error*.
- *TwinCat* users: Be aware that the system level designer might have chosen to disable direct error event reporting from the Triamec module to the user. It is at the system level designers responsibility to propagate the plc-axis errors during commissioning in this case.

Some internal tests (flash and RAM-tests) are only done during 24V start-up and after resetting an *STO* fault. Make sure any one of the following procedures is done minimum once a year:

- Turn off 24V for at least 10s or
- Generate an *STO error*, e.g., *STO-Inconsistent* (a *STO-Active warning* is not sufficient) or
- Software activation of this error is also possible, ask Triamec Motion AG for details.

5.6.3 Functional Description

The servo drives power stage may be activated only, if both *STO* channels are enabled. These channels engage the power supply of the semiconductor drivers.

Cutting any of these two channels below U_{Safe}^{STO} will deactivate the drivers and the motors do not receive any energy after a maximum time of t_{Safe}^{STO} (process safety time). This feature has priority over software and can not be disabled by software. For external diagnostic purposes, the channels may be pulsed with 0V pulses of maximum duration t_{Ignore}^{STO} at a maximum rate of f_{Ignore}^{STO} .

5.6.3.1 Standard Case

If STO is activated simultaneously on both channels as intended, the servo drive will enter a safe state:

- The warning state *Not-ReadyToSwitchOn/STO-Active* is entered when STO is activated from the switched off state *ReadyToSwitchOn*. This state is left without reset, if the STO is inactivated.
- The error state *FaultPending/STO-Active* is entered when STO is activated from the switched on state *Operational*. This state is left only with a reset command. The next state is either a warning state *Not-ReadyToSwitchOn* if a warning condition is still active (i.e., *STO-active*, temperature, bridge-voltage) or the ready state, if the *STO* is inactivated.

5.6.3.2 Serious Case

In addition to these standard *Safe-States*, there are a couple of *Safe-Error-States*. These require a user initiated reset for recovery. During recovery, there is a power-up test of the internal diagnostic circuit which takes about 40ms. The important causes from a user perspective are:

- If the logic levels of the two channels are not equal during more than $t_{Inconsistent}^{STO}$, the servo drive enters the safe error state *STO-Inconsistent*.
- Internal diagnostic startup test failure: The servo drive enters the safe error state *startup test of the safety circuit failed*.
- Internal periodic pulse test failure: The servo drive enters the safe error state *STO-PulseTestFailure*.
- If the internal diagnostic circuit temperature is out of range, the servo drive enters the safe error state *STO-Temperature-Limit*.

Safety Information	
	A spontaneous defect of two power semiconductors may cause a maximum movement of 120° (electrically).

Voltages outside of the specifications:

- The STO inputs are protected up to voltages of 40V by a thermal (recoverable) fuse.
- If the 24V Supply voltages exceed 29V, the servo drive will enter and remain in the safe state. For Rev. 1 an irreversible fuse will break and the servo drive requires factory maintenance. For Rev. 2 and higher, the internal power supply switches off and the servo drive requires a 24V power cycle.
- Too small 24V supply voltages also cause entering the safe state.

5.6.4 Safety Characteristic Data

The following table shows safety specification (in addition to the electrical *STO* specification in chapter 5.2.1).



	Value
Safety level	SIL3 Ple CAT 3
PFH	3E-9 h ⁻¹
PFD	2E-4 (Proof-Test Interval equals Mission Time)
SFF	95% for <i>STO</i> (Hardware Fault Tolerances HFT1) 96% for Diagnostics (Hardware Fault Tolerances HFT0)
Type	A (according to 61508-2)
DC	92%
MTTFd	100a
Mission time TM	20a

5.6.5 Prohibited Use

The *STO* function must not be used in the following cases:

- Cleaning
- Maintenance
- Repair operations
- Long inoperative periods

In such cases, the entire system should be disconnected from the supply by the personnel and secured.

Symbol	Safety Information
	<p>Risk of injury from suspended loads! If the <i>STO</i> function is activated, the amplifier cannot hold the load, the motor no longer supplies torque. Axes with suspended loads must also be safely blocked mechanically (e.g. with the motor holding brake). If engaged during operation, the motor runs down out of control. There is no possibility of braking the axes controlled. If a controlled braking before the use of <i>STO</i> is necessary, the servo drive must be braked and the <i>STO</i> inputs have to be separated from +24 VDC in a time-delayed manner.</p> <p>Keep to the following functional sequence when <i>STO</i> is used:</p> <ol style="list-style-type: none"> 1. Stop the servo drive in a controlled manner (command stop or emergency stop) 2. When speed = 0, disable the servo amplifier (enable = 0V) 3. If there is a suspended load, block the servo drive mechanically 4. Activate <i>STO</i> (STO1-Enable and STO2-Enable = 0V)
	<p>The function <i>STO</i> does not provide an electrical separation from the power output. If access to the motor power terminals is necessary, the servo amplifier must be disconnected from mains supply considering the discharging time of the intermediate circuit. There is a danger of electrical shock with personal injury.</p>

5.7 Commutation Frequency Limitation

The European Union issued export restrictions for frequency converters to some countries. Under some conditions, export to these countries is simplified. Triamec servo drives for simplified export contain a limitation of the commutation frequency described in this document. For the correct ordering details refer to chapter 3.1.4.

A product, ordered without high speed capability, contains the frequency limitation feature. This limits the electrical commutation frequency to 600Hz. Moves with speed above this commutation frequency limit will throw the error *Commutation600HzLimit* and the axis stops.

The commutation frequency is related to the mechanical speed by the following equations:

5.7.1 Rotational Motor

The following formula checks if the high speed capability is necessary for a rotational motor.

$$\frac{n \cdot p}{60 \text{ s/min}} = \frac{\text{axis}[\text{ }].\text{signals}.\text{commutation}.\text{velocity}}{2 \cdot \pi} < 600 \text{ Hz}$$

$n[\frac{1}{\text{min}}]$: mechanical speed

p : pole-pairs per turn

5.7.2 Linear Motor

The following formula checks if the high speed capability is necessary for a linear motor.

$$\frac{v}{d_m} = \frac{\text{axis}[\text{ }].\text{signals}.\text{commutation}.\text{velocity}}{2 \cdot \pi} < 600 \text{ Hz}$$

$v[\frac{m}{s}]$: velocity

$d_m[m]$: distance of the magnetic period

5.7.3 DC Motor

No limitation

5.8 Mechanical Specifications



	TSD350
Weight	3100g
Dimensions: W x H x D	69 x 263 x 230mm ³

5.9 Ambient and Mounting Conditions

	TSD350
Site altitude	up to 1000m above sea level without restriction, higher than 1000m above sea level with reduced power 1% per 100m, max. 2500m above sea level
Mounting Position	Vertical or horizontal, see chapter 6.2
Ambient temperature in operation	According to IEC60721-3-3 class 3K3 +5°C (41°F) to +40°C (104°F), max. rate of change 20K / hour
Humidity in operation	5 to 85% without condensation
Cooling System	The unit has a fan which is speed controlled. This increases the life time of the fan and reduces acoustic noise. Care should be taken not to block the air inlet and outlet on the bottom and top-side of the unit. The servo drive is equipped with temperature monitoring at various positions inside the drive, which switches the servo drive off in case of over-temperature. The servo drive switches off if the heat sink temperature is above 70°C (158°F).
Enclosure protection	IP 20 (according to IEC 60529 standard)
Pollution Level	Level 2 as per IEC 60664-1
Type of installation 	Built-in unit, only for installation in a stationary control cabinet with min. degree of protection IP4x. According to EN ISO 13849-2 the control cabinet must have degree of protection IP54 or higher when using the safety function STO (Safe Torque Off).
Vibrations of System	The servo drive is intended for stationary use only and must not be installed in areas where they would be permanently exposed to vibrations. The mechanical conditions must respect the class 3M3 of the IEC 60721-3-2 standard.

6 Mechanical Installation

6.1 Safety Instructions

Symbol	Safety Information
	<ul style="list-style-type: none"> - There is a danger of electrical shock by high EMC level which could result in injury, if the servo amplifier (or the motor) isn't properly EMC-grounded. - During installation work strictly avoid that drill chips, screws or other foreign substances drop into any device. Strictly prevent the devices from moisture. - Protect the servo amplifier from impermissible stresses. In particular, do not let any components become bent or any insulation distances altered during transport and handling. Avoid contact with electronic components and contacts.
	<ul style="list-style-type: none"> - The device heats up during operation and the temperature on the heat sink may reach high temperatures. Please bear this in mind for adjacent components. - Cooling air must be able to flow through the devices without restriction. For installation in control cabinets with convection, always fit an internal air circulation fan. - The servo drive will switch-off itself in case of overheating. Ensure that there is an adequate cooling in the control cabinet.
	<ul style="list-style-type: none"> - Protect the servo amplifier from impermissible stresses. In particular, do not let any components become bent or any insulation distances altered during transport and handling. Avoid contact with electronic components and contacts.

Notice: Do not mount devices, which produce magnetic fields, directly beside the servo drive. Strong magnetic fields could directly affect internal components. Install devices which produce magnetic field with distance to the servo drive and/or shield the magnetic fields.

6.2 Guide to Mechanical Installation

The following notes help to carry out the mechanical installation.

6.2.1 Site

- The servo drive should be mounted into a lockable control cabinet. Refer to chapter 5.9.
- The site must be free from conductive or corrosive materials.

6.2.2 Cooling

- The servo drives shall be spaced with a gap (A) of 5mm laterally. Keep the required space of 50mm clear above and below the servo drive and do not cover air inlets and outlets with cables.
- The servo drive will shut down if the temperature on the PCB, below the power stage, reaches 70°C.

6.2.3 Mounting

- Assemble the servo drives and power supply close together, on the conductive, grounded mounting plate in the cabinet.
- Mount the servo drive preferably in vertical position as depicted in Figure 2 (horizontal position is allowed too).
- There are two mounting holes for this purpose at the back side of the drive.

	TSD350
Gap A(between drives)	≥5mm
Gap B (air inlet and outlet)	≥50mm
Screws	2 x M4 or M5
Hole Spacing	252.5mm

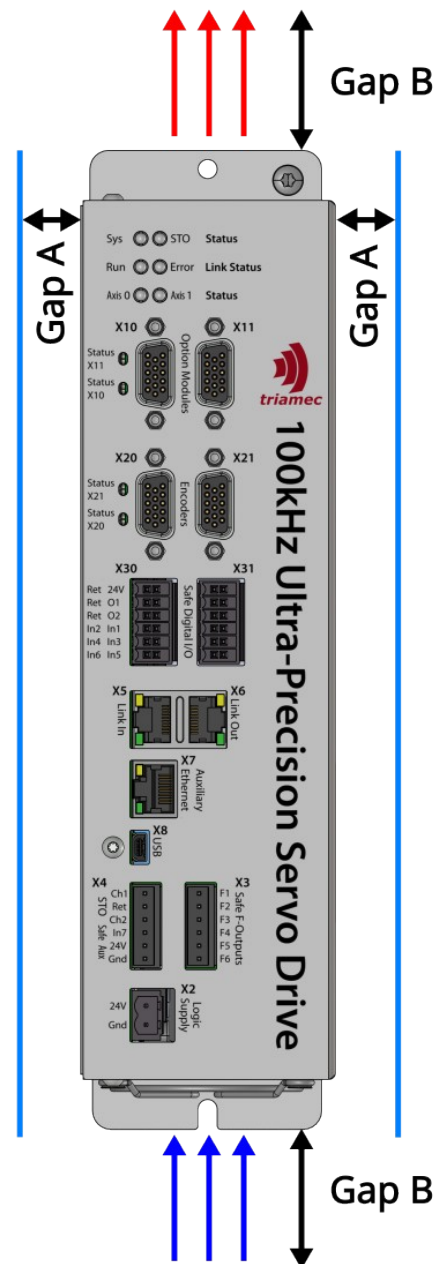





Figure 2: Mounting and cooling

7 Electrical Installation

7.1 Safety Instructions

Symbol	Safety Information
	<p>There is a danger of electrical arcing with serious personal injury. Never connect or disconnect electrical connections while power of any source is on. Isolate the device from the power supply before working on it. Wait at least ten minutes after disconnecting the servo drive from the main supply power before touching potentially live sections of the equipment (e.g. contacts) or undoing any connections.</p> <p>Control and power connections can still be live, even if the motor is not rotating. Capacitors can still have dangerous voltages present up to ten minutes after switching off the power supply. Work on the device must only be carried out, after the DC link voltage has dropped below a residual voltage of 40V (to be measured on terminal X1).</p>
	<p>Installation is permitted for properly qualified personnel only. Only professional staff who are qualified in electrical engineering are allowed to install the servo drive. The qualified personnel must know and observe the following standards:</p> <ul style="list-style-type: none"> • IEC 60364 and IEC 60664 • national accident prevention regulations
	<p>During installation work strictly avoid that screws, cable oddments or other foreign substances drop into any device. Strictly prevent the devices from moisture.</p>
	<p>Wrong DC-Bus voltage, unsuitable motor or wrong wiring will damage the amplifier. Check the combination of servo amplifier and motor. Compare the rated voltage and current of the units. Implement the wiring according to the connection diagram in Chapter 7.5. Make sure that the maximum permissible rated voltage at the terminal X1 is not exceeded by more than 5%.</p>

Notice: Compliance with the EMC product standard Commissioning (i.e. starting intended operation) is only permitted when strictly complying with EMC product standard EN 61800/-3:2004. The installer/operator of a machine and/or equipment must provide evidence of the compliance with the protection targets stipulated in the EMC-standard.

Notice: Correct wiring is the basis for reliable functioning of the servo system. Route power and control cables separately. We recommend a distance of at least 100mm. This improves the interference immunity.

Notice: Use only shielded motor and signal lines with at least 70% shielding coverage.

Notice: Feedback lines may not be extended, since thereby the shielding would be interrupted and the signal processing could be disturbed.

Notice: Always route the motor cable without interruptions and the shortest way out of the control cabinet.

- If possible enter signal lines only from one side into the control cabinet.
- Lines of the same electric circuit must be twisted.
- Avoid unnecessary cable lengths and loops.

7.2 Guide to Electrical Installation

The following notes help to carry out the electrical installation. The installation procedure is described as an example. A different procedure may be appropriate or necessary, depending on the application of the equipment.

7.2.1 Connectors and Cables

- Select cables according to the specification of each connector in chapter 7.

7.2.2 Grounding

- For EMC grounding refer to chapter 7.5.1 and 7.12.1.
- Make sure there are two protective earth connections.
- Ground the mounting plate, motor housing and the GND of the control system.

7.2.3 Wiring and Shielding

- Route power leads and control cables separately.
- Connect the protective earth (PE) to the dedicated screws!
- Wire the STO contacts as discussed in chapter 7.7.
- Connect the digital inputs and outputs.
- Connect the auxiliary Supply for the digital outputs.
- Connect the feedback device (encoder) and its shielding.
- Connect the motor cable and its shielding at both ends.
Make sure the length is within the EMC specification in chapter 5.3.
- Connect motor-holding brake if needed and its auxiliary supply, connect shielding at both ends.
- Connect the DC-Bus to the Power supply. Make sure the DC-Bus connection to the power supply is as short as possible.
- Connect the fieldbus (*Tria-Link* or *EtherCAT*).

7.2.4 Final Check

- Final check of the wiring against the wiring diagrams that have been used.

7.3 Overview of Servo Drive Connections

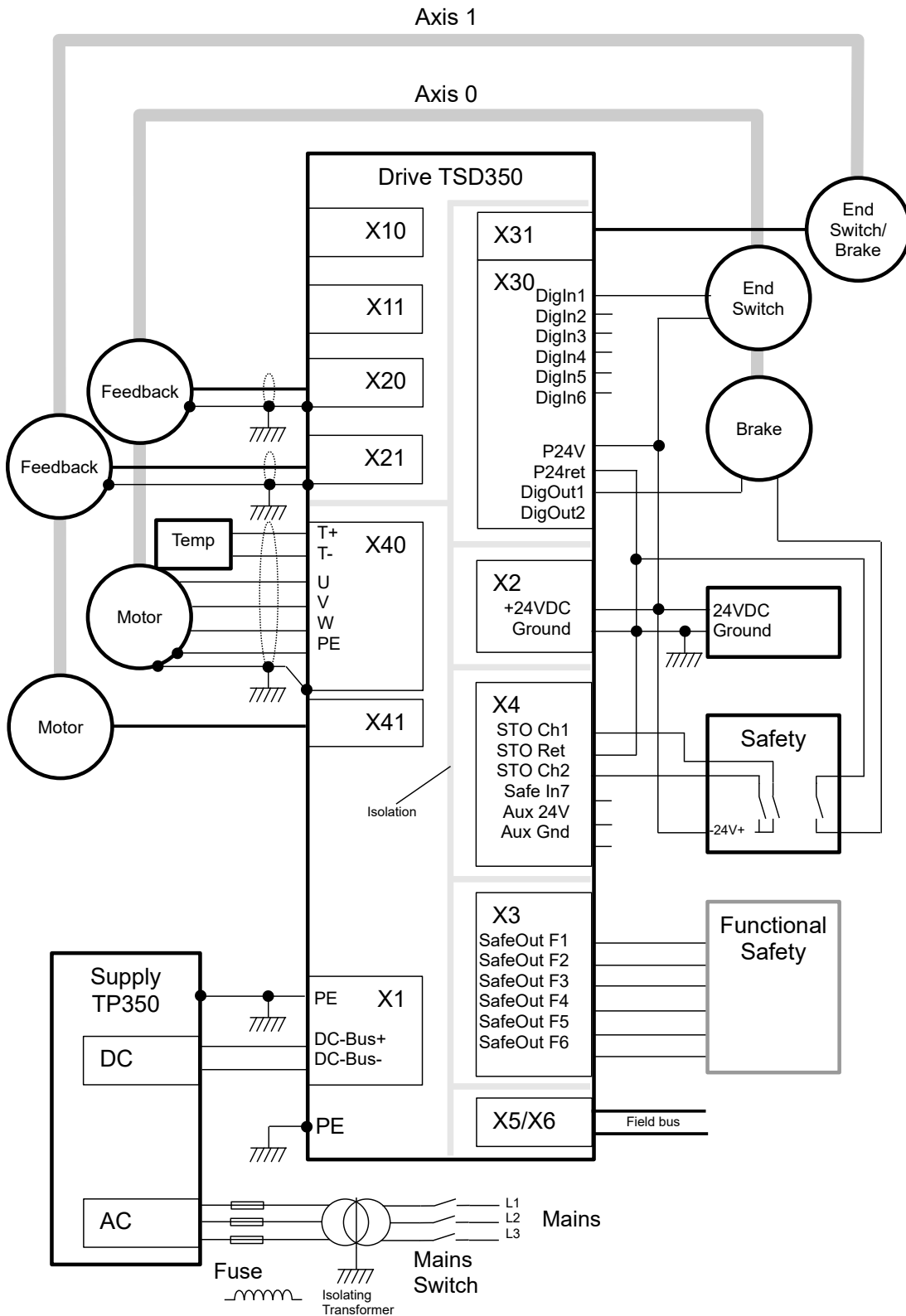

Figure 3: Connection diagram TSD350

7.4 Connectors and Terminals

The illustration on the right side shows the servo drive with the corresponding positions of plugs and terminals. All signals of the servo drive, *STO* and 24V logic supply are accessible from the front plate. Power connectors are at the top side of the drive. Motor connectors are located at the bottom of the servo drive.

The second earth contact PE and the PE wire of connector X1 must both be connected to protective earth with a wire cross-section equivalent to the DC-Bus wires.

The table below gives an overview for each connector. The column on the far right contains a reference to a sub chapter or application note with further details.

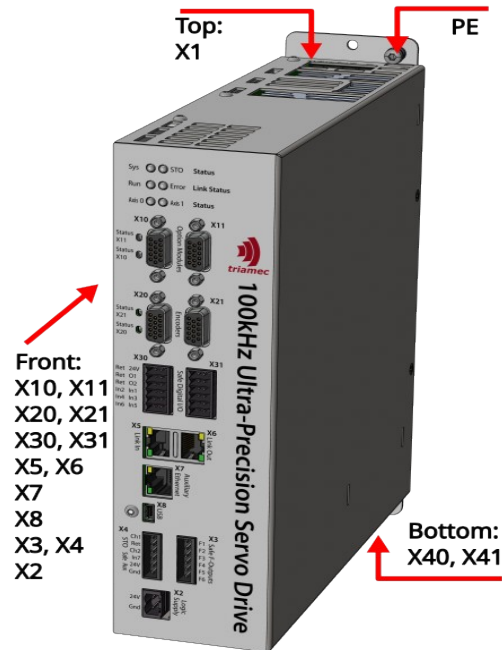

Figure 4: Overview of the connectors

Connector	Direction	Terminals	Mating Connector Type	Details
X1	In	DC-Bus	Weidmüller, BVF 7.62HP/03/180MF3 SN BK BX Order-No.: 1060580000, 3 pins, 7.62mm pitch	7.5.1
X2	In	Logic Supply (24V)	Weidmüller, BLF 5.08HC/02/180 SN BK BX Order-No.: 1013430000, 2 pins, 5.08mm pitch	7.5.2
X3	Out	Safe F-Outputs (currently unused)	Weidmüller, BL 3.50/06/180 SN BK BX Order-No.: 1610180000, 6 pins, 3.5mm pitch	5.6, 7.6
X4	In	Safe torque Off	Weidmüller, BL 3.50/06/180 SN BK BX Order-No.: 1610180000, 6 pins, 3.5mm pitch	5.6, 7.7
X5/X6	In/Out	<i>Tria-Link</i> or <i>EtherCAT</i>	RJ-45 connector	7.8
X7	In/Out	The Ethernet connector can be connected to a TCP/IP Network. It's possible to monitor and configure the servo drive within Triamec <i>TAM System Explorer</i> .		[6]
X8	In/Out	The USB connector (mini-B) can be connected to a Microsoft® Windows® based notebook/PC. It's possible to monitor and configure the servo drive within Triamec <i>TAM System Explorer</i> .		[2]
X10/X11	In/Out	Option modules	15 pin Sub-D high-density connector (male)	7.9
X20/X21	In	Encoder	15 pin Sub-D high-density connector (male)	7.10
X30/X31	In/Out	Digital I/O	Weidmüller, B2CF 3.50/12/180LH SN BK BX Order no.: 1375750000 (for coding, see option ³)	7.11
X40/X41	Out	Motor(s)	Weidmüller, BVF 7.62HP/4/180MF4 BCF/6 SNBKBXSP180SO Order-No.: 2940440000, 4 pins 7.62mm pitch & 4 pins)	7.12.1

7.5 Electrical Supplies (X1, X2)

The power supply for the servo drive is separated into the supplies for logic and power sections.

Notice: The DC-Bus voltage can be switched on and off independently of the Logic Power. Standard operating procedure, however, is to power the logic before powering DC-Bus.

7.5.1 DC-Bus (X1)

The servo drive must be supplied with a DC voltage source as specified in chapter 5.2.1. Use the DC-bus connector X1 at the top side of the drive. There must be two protective earth connections.

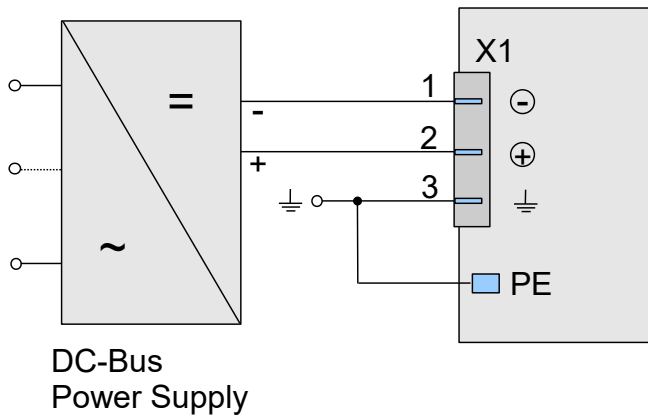

Figure 5: DC-Bus connector (X1)

Figure 6: DC-Bus connection.

Pin Layout X1	Pin	Name	Description	Min. Cross Section of Wire	Max. Current
	1	-DC-Bus	DC-Bus ground	TSD350-10: 2.5mm ² TSD350-15: 4.0mm ²	20 Arms 30 Arms
	2	+DC-Bus	DC- Bus positive voltage	TSD350-10: 2.5mm ² TSD350-15: 4.0mm ²	20 Arms 30 Arms
	3	PE	Protective earth	Same or larger than DC-Bus	

Information	
 CAUTION	<p>Hot-plugging of the DC-bus link connector is strictly forbidden. The servo drives have large internal capacitors. It is therefore also forbidden to have a simple power-switch or relay in the DC-bus link, because this will also cause large inrush currents.</p> <p>A power-switch or relay in the DC-bus link is allowed only, if it has a soft-start functionality as supplied by the Triamec power supplies <i>TP350</i>.</p>
 CAUTION	<p>Please note if not using a <i>Triamec</i> power supply: The servo drives have no built in brake-resistor. When decelerating a mechanical load, currents can get negative, refer to chapter 5.5.</p>

Notice: The Triamec Motion AG power supply *TP350* complement these servo drives that do not include an integral power supply. Its recommended to use the Triamec power supplies, see also chapter 5.3 on EMC.

7.5.2 24V Logic Supply (X2)

The servo drive requires a 24V DC supply (PELV type mandatory) for its internal logic and for the supply of the connected encoders. The Logic Supply connector X2 is found at the front side of the drive.

The servo drive internal supplies are galvanically isolated from the 24V DC logic supply input, especially the encoder supply and the motor temperature input. The STO supply used to bypass STO is not galvanically isolated from this input.

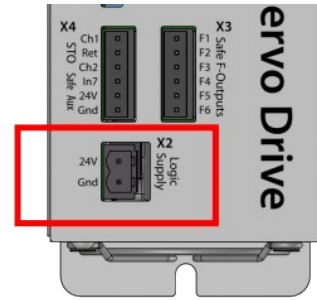

Figure 7: 24V Logic supply connector (X2)

Pin Layout X2	Pin	Name	Description
	1	+24VDC	Supply logic positive voltage
	2	Ground	Supply ground

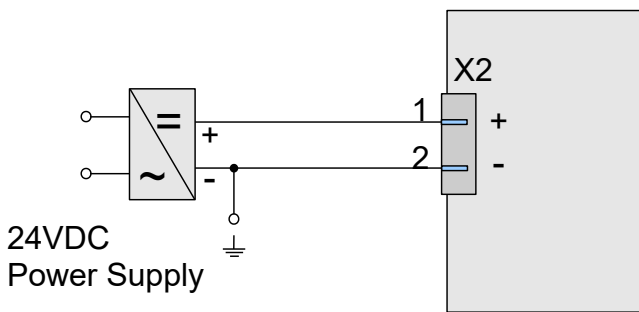

Figure 8: 24VDC logic power supply connection

Information	
	As per EN 61800-5-1, the used power supply must have a safe and reliable galvanic isolation towards the mains network.

Notice: It's recommended, to connect the 0VDC (-) to earth potential near the power supply. This ensures that the low voltage side complies with PELV.

7.6 Safe Function Outputs (X3)

The Safe Function Output connector X3 is found at the front side of the drive. The cable must be shorter than 20m. Use shielded cables if longer than 0.5m.

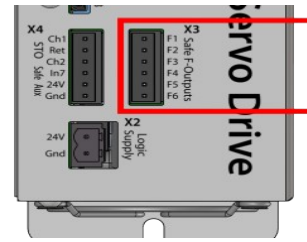



Figure 9: Safe Function Outputs connector (X3)

Pin Layout X3	Pin	Name	Description
	1	Safe F-Output F1	Safe Function Output F1 (don't connect, currently not available)
	2	Safe F-Output F2	Safe Function Output F2 (don't connect, currently not available)
	3	Safe F-Output F3	Safe Function Output F3 (don't connect, currently not available)
	4	Safe F-Output F4	Safe Function Output F4 (don't connect, currently not available)
	5	Safe F-Output F5	Safe Function Output F5 (don't connect, currently not available)
	6	Safe F-Output F6	Safe Function Output F6 (don't connect, currently not available)

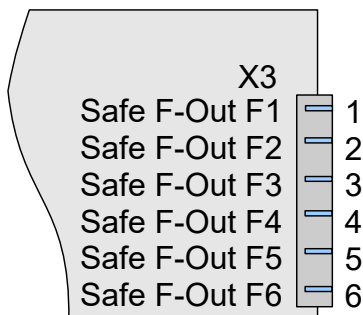

Figure 10: Wiring of the Safe Function Outputs (currently not available)

7.7 Safe Torque Off STO (X4)

The STO connector X4 is found at the front side of the drive. The cable must be shorter than 20m. Use shielded cables if longer than 0.5m.

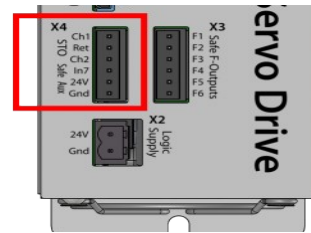

Figure 11: STO connector (X4)

Pin Layout X4	Pin	Name	Description
	1	STO Input Ch1	STO channel 1 input
	2	STO Return	GND
	3	STO Input Ch2	STO channel 2 input
	4	Safe Input 7	Safe Input 7 (don't connect, currently not available)
	5	Aux 24 V	24V for STO, if STO is not used (connect to Pin 1 and 3 of X4)
	6	Aux Gnd	Ground for STO, if STO is not used (connect to Pin 2 of X4)

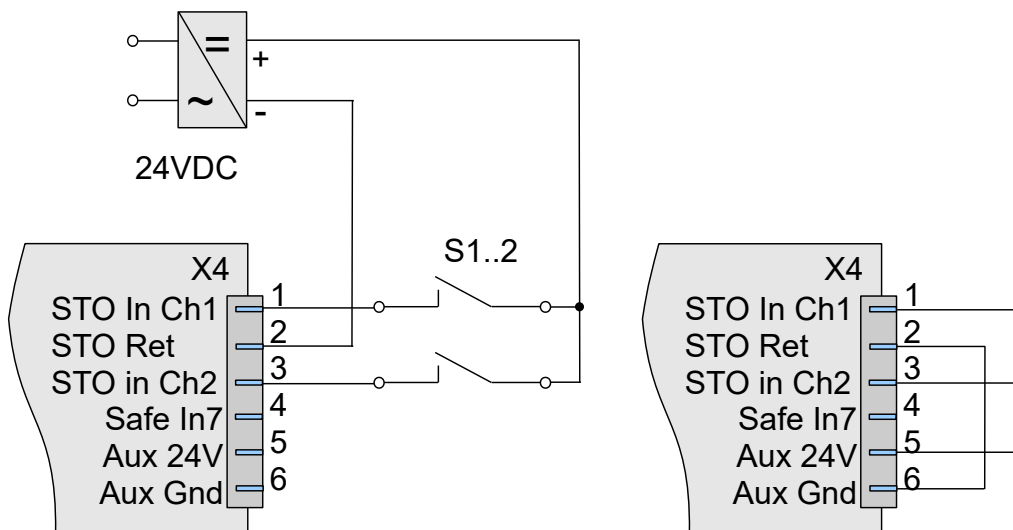

Figure 12: Wiring of the STO used (left) and not used (right)

7.8 Fieldbus Connection (X5, X6)

The servo drive communicates with the host (and other devices) using one of two possible Ethernet-based fieldbuses.

Use quality Cat. 5E or 6, double shielded, standard Ethernet cables.

7.8.1 Tria-Link

This is a flexible bus developed by Triamec. The servo drive must be connected with the other Triamec devices and the Triamec PCI-Adapter card forming a ring topology. Both jacks (X5, X6) are equivalent, they can be used in any order and are completely interchangeable.

Each *Tria-Link* RJ-45 connector has two LEDs:

- The green LED (Link LED) is normally blinking. This indicates that the *Tria-Link* is connected to the next device. If one of the green LEDs is not blinking, it indicates an open link to the next device. Check device 24V and the cable/Ethernet connector in this case.
- The yellow LED (Lock LED) indicates a successful time synchronization of all devices in the *Tria-Link*, and thus that the link is ready. If the yellow LED is not illuminated at least ~5sec after servo drive start up, the *Tria-Link* is either:
 - ♦ open, i.e. the ring is not closed or an Ethernet connector is not engaged
 - ♦ one or more devices are not powered
 - ♦ a device has a hardware fault.

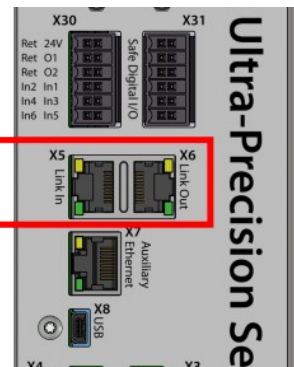

Figure 13: Link jacks (X5, X6)

7.8.2 EtherCAT

This is a fieldbus disclosed in the IEC standard IEC61158 with real-time capability. It was originally developed by Beckhoff Automation and is now managed by the *EtherCAT* Technology Group (ETG).

The servo drive must be connected to the *EtherCAT* PCI-Adapter card and the other Triamec devices in a chain topology starting with the Adapter card. The jacks (X5(Line In), X6(Line Out)) are not equivalent, the control flow has to be regarded.

- In contrast to the *Tria-Link*, the cyclic data is defined at boot time and cannot be changed later. This makes debugging through the fieldbus less flexible than with the *Tria-Link*. However, customers may still use the USB or Ethernet interface for debugging within Triamec *TAM System Explorer*.
- Exchange of cyclic data between slaves is less flexible than with *Tria-Link* and is not supported.

Each *EtherCAT* RJ-45 connector has two LEDs:

- The green LED (Line In) is on, to indicate that the servo drive is connected to the Controller. If the green LED is Off, it indicates an open connection. Check device 24V and the cable/Ethernet connector in this case.
- The yellow LED (Line Out) is normally Off, except the LED of the last Device in the chain is flashing.

7.9 Option Modules (X10, X11)

Two *Option Module* connectors provide access to extended functions. *Option Module* orders are defined with the drive order key and are installed during production. Post-production installations are possible by sending the drive back to *Triamec*.

The chapter 3.1.5 describes the different available options. Please refer to [5] for further informations about functionality, pinout and software access.

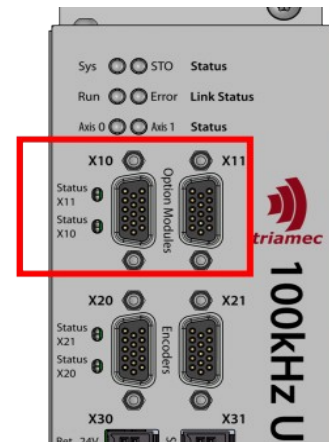

Figure 14: Option module jacks (X10,X11)

7.10 Encoder (X20, X21)

Two encoder connectors are available by default (two more are available with option modules). They are located at the front side of the drive. X20 feeds axis 0. X21 feeds axis 1.

Each connector supports various encoder types/protocols and up to four high speed TTL inputs (200ns).



Figure 15: Encoder jack (X20,X21)

Type	Description
Analog sin/cos Encoder with Index	High resolution analog sin/cos encoder with index channel.
Digital Encoder with sin/cos Signals	High resolution analog encoder combined with absolute encoder position, which is transmitted digitally.
Digital Encoder without sin/cos Signals	Digital encoder without analog sin/cos signals. Encoder specifications limit the maximum possible update rate of the controller.
Incremental RS422 Encoder with Index	RS422 incremental encoder.
Incremental RS422 Fast Encoder	RS422 encoder input for frequencies up to 10MHz.
Incremental TTL Encoder with Index	TTL incremental encoder.

Information	
 CAUTION	<ul style="list-style-type: none"> - Make sure the encoder plug is well connected by means of the D-Sub plug screws. - Do not split encoder cables, for example to route the signals via terminals into the control cabinet. - Connect the case with the shielding of the encoder cable and make sure, that the screen is connected with low impedance (i.e. thick wire, large connection area, 360 degree around the cable) at the servo drive side.

7.10.1 Analog sin/cos Encoder with Index

Analog sin/cos Encoder with index channel.

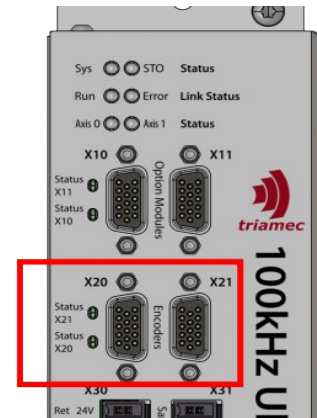
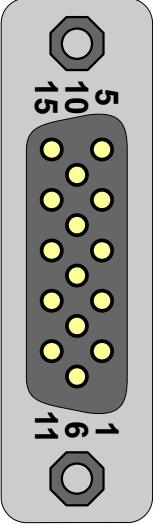

Figure 16: Encoder jack (X20,X21)

Pin Layout X20/X21	Pin	Name	Encoder	
15-pin female D-Sub socket 	1	+5VDC	Encoder Supply	
	2	ChA+	Channel A positive, Cosine 1Vpp	
	3	ChB+	Channel B positive, Sine 1Vpp	
	4	ChZ+	Index channel positive, RS-422 input	
	5	n.c.	do not connect	
	6	Gnd	Supply Ground	
	7	ChA-	Channel A negative, Cosine 1Vpp	
	8	ChB-	Channel B negative, Sine 1Vpp	
	9	ChZ-	Index channel negative, RS-422 input	
	10	n.c.	do not connect	
	11	EnIn0	TTL Level Input No. 0 (max 5VDC Input)	see 7.10.7 for connection
	12	EnIn1	TTL Level Input No. 1 (max 5VDC Input)	see 7.10.7 for connection
	13	EnIn2	TTL Level Input No. 2 (max 5VDC Input)	see 7.10.7 for connection
	14	EnIn3	TTL Level Input No. 3 (max 5VDC Input)	see 7.10.7 for connection
	15	Gnd	Signal Ground	

7.10.2 Digital Encoder with sin/cos Signals

Single-turn or Multi-turn Digital Encoder (EnDat 2.1/2.2, BiSS B, BiSS C) with analog sin/cos signals. This encoder type is operated as analog sin/cos Encoder. The Absolute position (and some additional information) is read during initialization using the digital serial interface.

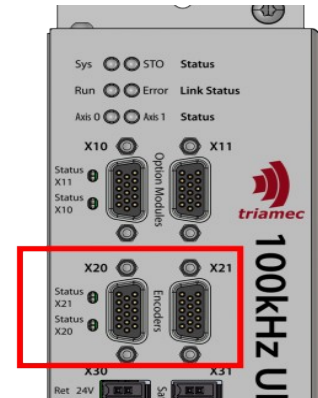
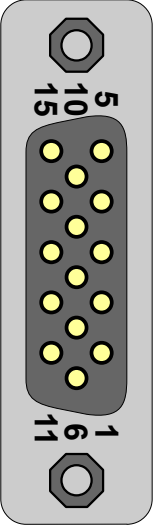

Figure 17: Encoder jack (X20,X21)

Pin Layout X20/X21	Pin	Name	Encoder	
15-pin female D-Sub socket 	1	+5VDC	Encoder Supply	
	2	ChA+	Channel A positive, Cosine 1Vpp	
	3	ChB+	Channel B positive, Sine 1Vpp	
	4	DATA+	Data channel positive, RS-422	
	5	CLOCK+	Clock channel positive, RS-422	
	6	Gnd	Supply Ground	
	7	ChA-	Channel A negative, Cosine 1Vpp	
	8	ChB-	Channel B negative, Sine 1Vpp	
	9	DATA-	Data channel negative, RS-422	
	10	CLOCK-	Clock channel negative, RS-422	
	11	EnIn0	TTL Level Input No. 0 (max 5VDC Input)	see 7.10.7 for connection
	12	EnIn1	TTL Level Input No. 1 (max 5VDC Input)	see 7.10.7 for connection
	13	EnIn2	TTL Level Input No. 2 (max 5VDC Input)	see 7.10.7 for connection
	14	EnIn3	TTL Level Input No. 3 (max 5VDC Input)	see 7.10.7 for connection
	15	Gnd	Signal Ground	

Notice: RS422 index channel is not available in this configuration. TTL index is available through an EnInX.

7.10.3 Digital Encoder without sin/cos Signals

Single-turn or Multi-turn Digital Encoder (Endat 2.2, BiSS B, BiSS C, Tamagawa, Nikon) without analog sin/cos signals. Digital absolute position information is transmitted at every position controller cycle digitally coded to the position controller.

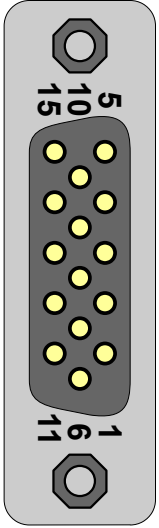

Figure 18: Encoder jack (X20,X21)

Pin Layout X20/X21	Pin	Name	Encoder	
15-pin female D-Sub socket 	1	+5VDC	Encoder Supply	
	2	n.c.	do not connect	
	3	n.c.	do not connect	
	4	DATA+	Data channel positive, RS-422	
	5	CLOCK+	Clock channel positive, RS-422 (not used for Nikon and Tamagawa)	
	6	Gnd	Supply Ground	
	7	n.c.	do not connect	
	8	n.c.	do not connect	
	9	DATA-	Data channel negative, RS-422	
	10	CLOCK-	Clock channel negative, RS-422 (not used for Nikon and Tamagawa)	
	11	EnIn0	TTL Level Input No. 0 (max 5VDC Input)	see 7.10.7 for connection
	12	EnIn1	TTL Level Input No. 1 (max 5VDC Input)	see 7.10.7 for connection
	13	EnIn2	TTL Level Input No. 2 (max 5VDC Input)	see 7.10.7 for connection
	14	EnIn3	TTL Level Input No. 3 (max 5VDC Input)	see 7.10.7 for connection
	15	Gnd	Signal Ground	

Notice: RS422 index channel is not available in this configuration. TTL index is available through an EnInX.

7.10.4 Incremental RS422 Encoder with Index

Connecting an incremental encoder with index channel.

This mode has a 500kHz limit and is provided for backwards compatibility. For new machines we recommend the 10MHz pinout as per 7.10.5 Incremental RS422 Fast Encoder with Index.

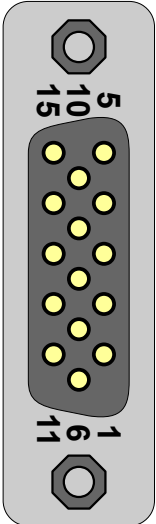

Figure 19: Encoder jack (X20,X21)

Pin Layout X20/X21	Pin	Name	Encoder	
15-pin female D-Sub socket 	1	+5VDC	Encoder Supply	
	2	ChA+	Channel A positive, RS-422 input	
	3	ChB+	Channel B positive, RS-422 input	
	4	ChZ+	Index channel positive, RS-422 input	
	5	n.c.	do not connect	
	6	Gnd	Encoder Ground	
	7	ChA-	Channel A negative, RS-422 input	
	8	ChB-	Channel B negative, RS-422 input	
	9	ChZ-	Index channel negative, RS-422 input	
	10	n.c.	do not connect	
	11	Encln0	TTL Level Input No. 0 (max 5VDC Input)	see 7.10.7 for connection
	12	Encln1	TTL Level Input No. 1 (max 5VDC Input)	see 7.10.7 for connection
	13	Encln2	TTL Level Input No. 2 (max 5VDC Input)	see 7.10.7 for connection
	14	Encln3	TTL Level Input No. 3 (max 5VDC Input)	see 7.10.7 for connection
	15	Gnd	Signal Ground	

7.10.5 Incremental RS422 Fast Encoder with Index

Connecting an incremental RS422 encoder with index for pulse frequencies up to 10MHz.

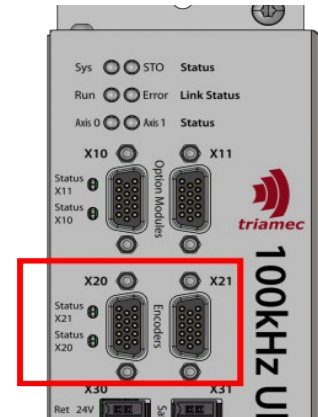
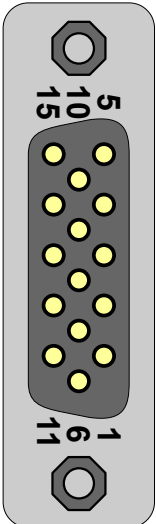

Figure 20: Encoder jack (X20,X21)

Pin Layout X20/X21	Pin	Name	Encoder	
15-pin female D-Sub socket  female D-Sub socket	1	+5VDC	Encoder Supply	
	2	ChZ+	Index channel positive, RS-422 input	
	3	n.c.	(do not connect)	
	4	ChA+	Channel A positive, RS-422 input	
	5	ChB+	Channel B positive, RS-422 input	
	6	Gnd	Encoder Ground	
	7	ChZ-	Index channel negative, RS-422 input	
	8	n.c.	(do not connect)	
	9	ChA-	Channel A negative, RS-422 input	
	10	ChB-	Channel B negative, RS-422 input	
	11	Encln0	TTL Level Input No. 0 (max 5VDC Input)	see 7.10.7 for connection
	12	Encln1	TTL Level Input No. 1 (max 5VDC Input)	see 7.10.7 for connection
	13	Encln2	TTL Level Input No. 2 (max 5VDC Input)	see 7.10.7 for connection
	14	Encln3	TTL Level Input No. 3 (max 5VDC Input)	see 7.10.7 for connection
	15	Gnd	Signal Ground	

7.10.6 Incremental TTL Encoder with Index

Connecting an incremental TTL encoder with index channel via Encln0 and Encln1.

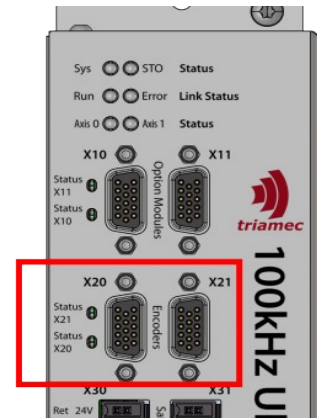
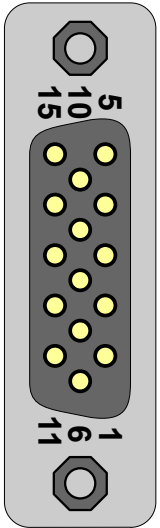

Figure 21: Encoder jack (X20,X21)

Pin Layout X20/X21	Pin	Name	Encoder	
15-pin female D-Sub socket  female D-Sub socket	1	+5VDC	Encoder Supply	
	2	n.c.	do not connect	
	3	n.c.	do not connect	
	4	ChZ+	Index channel positive, RS-422 input	
	5	n.c.	do not connect	
	6	Gnd	Encoder Ground	
	7	n.c.	do not connect	
	8	n.c.	do not connect	
	9	ChZ-	Index channel negative, RS-422 input	
	10	n.c.	do not connect	
	11	Encln0	Channel A	
	12	Encln1	Channel B	
	13	Encln2	TTL Level Input No. 2 (max 5VDC Input)	see 7.10.7 for connection
	14	Encln3	TTL Level Input No. 3 (max 5VDC Input)	see 7.10.7 for connection
	15	Gnd	Signal Ground	

Notice: The source of position latch during homing can be chosen between ChZ (RS-422), Encln2 or Encln3.

7.10.7 TTL Inputs Connection

If digital TTL inputs Encln0 ... Encln3 are used, they must be wired as follows using pull-up resistors.

We recommend pull-up resistors with 2.2kOhm. Shielding is mandatory for better EMC immunity. The shield has to be connected to the D-Sub housing (earth).

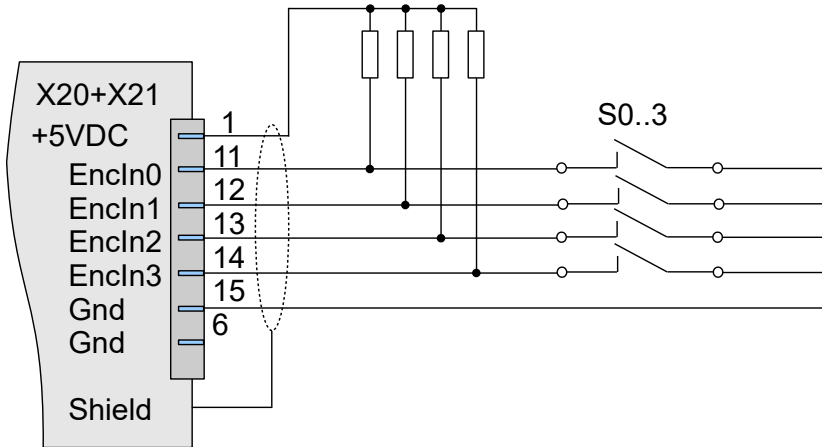

Figure 22: TTL input connection

7.11 Digital Inputs and Outputs (X30, X31)

The digital inputs and outputs are available at the front side of the drive. All inputs and outputs are galvanic isolated from the logic supply. The connectors X30 and X31 are not galvanically isolated to each other. X30 is assigned to axis 0, X31 is assigned to axis 1.

Notice: The outputs require an additional 24VDC power supply. If only the inputs are used, this is not necessary.

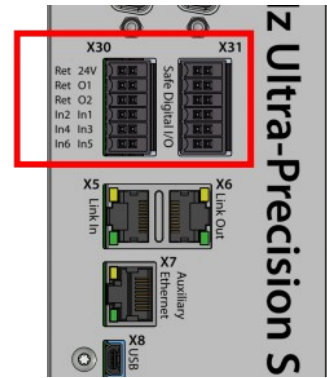

Figure 23: Digital I/O connector (X30+X31)

7.11.1 Digital Inputs

The pin numbering of the connector is shown in the figure below, see chapter 5.2.1 for detailed specifications of the input channels.

Pin Layout X30/X31	Pin	Name	Description	
	6	P24Vret	0V, ground for digital inputs. Internally connected to pins 2 and 4.	
	7	DigIn1	Digital input 1	
	8	DigIn2	Digital input 2	
	9	DigIn3	Digital input 3	
	10	DigIn4	Digital input 4	
	11	DigIn5	Digital input 5	
	12	DigIn6	Digital input 6	
				Logic low < 5V Logic high > 15V, max 29V

The digital inputs can be connected as depicted in the illustrations below.

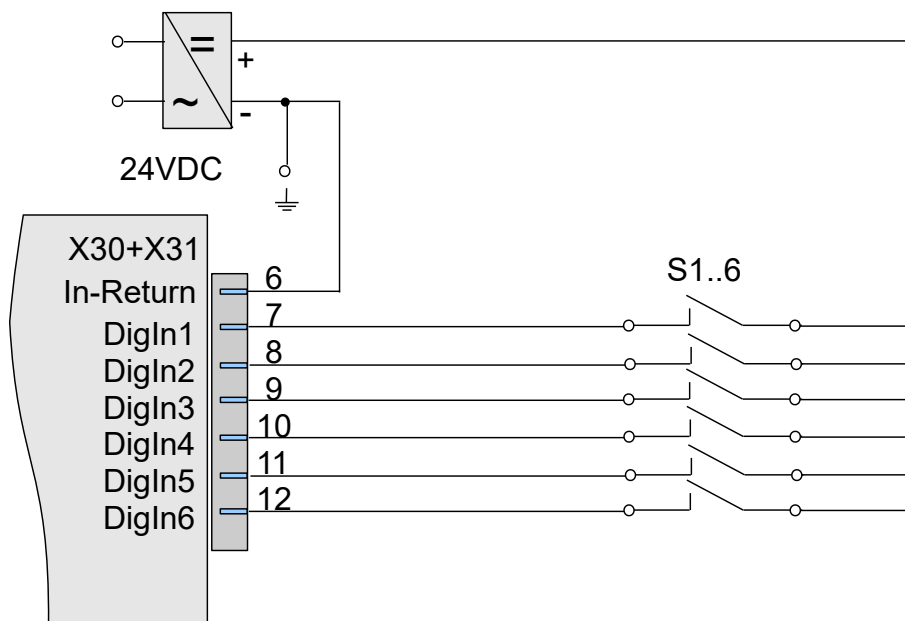
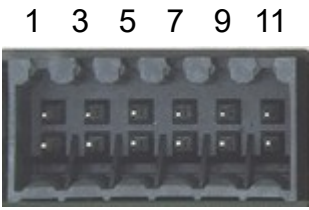

Figure 24: Digital input connection

7.11.2 Digital Outputs

The table below describes the pinout of the output pins, see 5.2.1 for detailed specification of the output channels. The digital outputs are high-side switches and require an external 24V_{DC} supply (PELV type mandatory) between pin 1 and pin 2 for operation.

Pin Layout X30/X31	Pin	Name	Description
	1	P24V	20...28VDC supply input for digital outputs 1 and 2. Current max. 2A continuous.
	2	P24Vret	0V, ground for digital outputs. Internally connected to pins 4 and 6.
	3	DO1	Digital Output 1 High Side Switch. Connect your load between this pin and pin 2, 4 or 6 (P24V-return) 30VDC max, 1A continuous ⁴ , 2A peak (1s)
	4	P24Vret	0V, ground for digital outputs. Internally connected to pins 2 and 6.
	5	DO2	Digital Output 2 High Side Switch. Connect your load between this pin and pin 2, 4 or 6 (P24V-return) 30VDC max, 1A continuous ⁴ , 2A peak (1s)
	6	P24Vret	0V, ground for digital outputs. Internally connected to pins 2 and 4.

As an example, the following figure shows the connection of a typical actuator (valve) at output DO2.

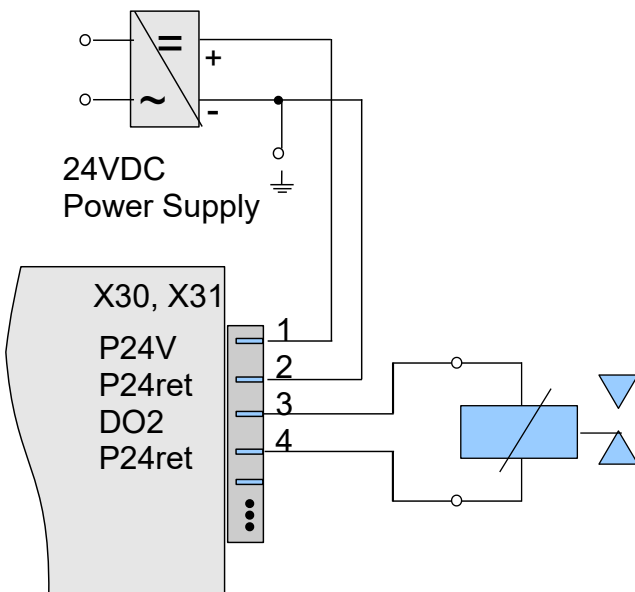

Figure 25: Typical actuator (valve) connection

Notice: Outputs DO1 are available at connector X40 and X41 too. This makes it possible to connect the motor brakes within the motor connector. See chapter 7.12.3 for details.

Warning: Do not use the digital output DO1 of X30 (X31) for any other function when the motor brake is connected through the connector X40 (X41) and occupies the output DO1 for the motor brake.

4 Max. 3.7A continuous for all 4 outputs together

7.12 Motor Connection (X40, X41)

This connector feeds the motor, the motor-holding brake and the motor temperature sensor.

7.12.1 Motor Power Connection

The servo drive supports different motor configurations. All motor configurations use connectors at the bottom side of the drive. X40 is for axis 0 and X41 is for axis 1. The motor cable must be shielded. The illustrations below show all possible motor configurations for each axis.



Figure 26: Motor connectors

Notice: Make sure protective earth on connector and functional earth on shield are connected properly.
Notice: For more information regarding recommended grounding and shielding instructions, refer to Triamec Motion AG Application Note "Grounding Instructions" [7].

7.12.1.1 3-Phase AC Motor Connection

Pin Layout X40/X41	Pin	Name	Description	Min. Cross Section of Wire	Max. Current
	1	W	Motor phase W voltage	TSD350-10: 1.0mm ² TSD350-15: 1.5mm ²	10 Arms 15 Arms
	2	V	Motor phase V voltage	TSD350-10: 1.0mm ² TSD350-15: 1.5mm ²	10 Arms 15 Arms
	3	U	Motor phase U voltage	TSD350-10: 1.0mm ² TSD350-15: 1.5mm ²	10 Arms 15 Arms
	4	PE	Protective earth	Same or larger than UVW	

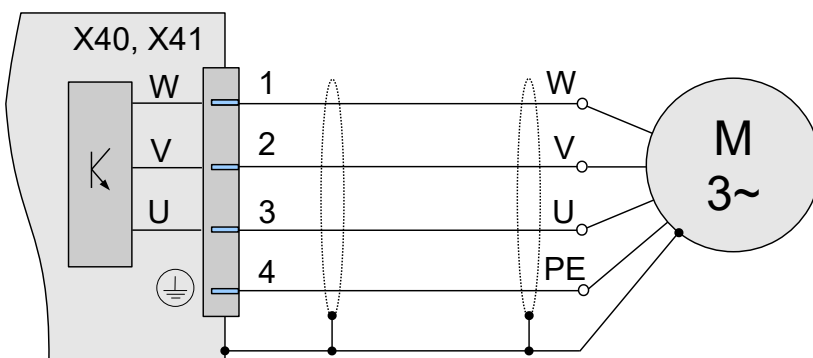

Figure 27: 3-phase motor connection

7.12.1.2 2-Phase AC Motor Connection

Pin Layout X40/X41	Pin	Name	Description	Min. Cross Section of Wire	Max. Current
	1	W	Motor phase P2 voltage	TSD350-10: 1.0mm ² TSD350-15: 1.5mm ²	10 Arms 15 Arms
	2	V	Motor phase P- voltage	TSD350-10: 1.0mm ² TSD350-15: 1.5mm ²	10 Arms 15 Arms
	3	U	Motor phase P1 voltage	TSD350-10: 1.0mm ² TSD350-15: 1.5mm ²	10 Arms 15 Arms
	4	PE	Protective earth	Same or larger than UVW	

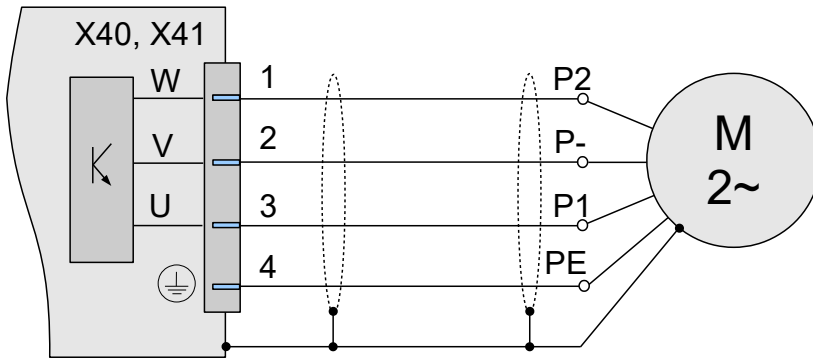

Figure 28: 2-phase motor connection

Notice: In case of a four wire motor, connect both return lines to phase V (Pin 2).

7.12.1.3 DC Motor Connection

Pin Layout X40/X41	Pin	Name	Description	Min. Cross Section of Wire	Max. Current
	1	W	nc	-	-
	2	V	Motor phase DC- voltage	TSD350-10: 1.0mm ² TSD350-15: 1.5mm ²	10 Arms 15 Arms
	3	U	Motor phase DC+ voltage	TSD350-10: 1.0mm ² TSD350-15: 1.5mm ²	10 Arms 15 Arms
	4	PE	Protective earth	Same or larger than UVW	

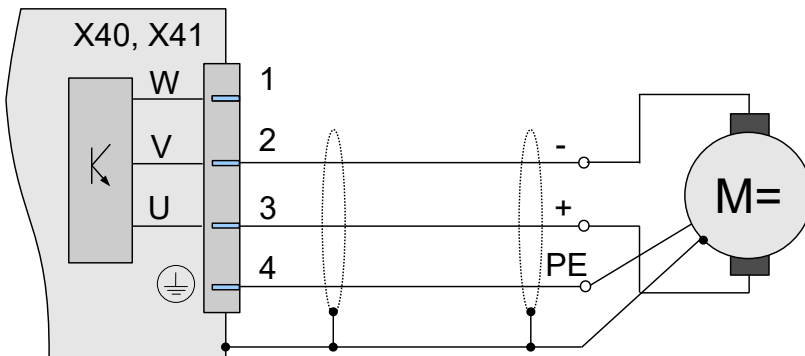



Figure 29: DC-motor connection

7.12.2 Motor Temperature

A resistive motor temperature sensor which measures the temperature of the motor windings may be connected to X40 and X41, see chapter 5.2.1 for supported types and ranges. Use X40 for axis 0 and X41 for axis 1.



Figure 30: Motor connectors

Pin Layout X40/X41	Pin	Name	Description
	1..4		
	5	Temp +	Positive motor temperature input
	6	Temp -	Negative motor temperature input
	7..8		

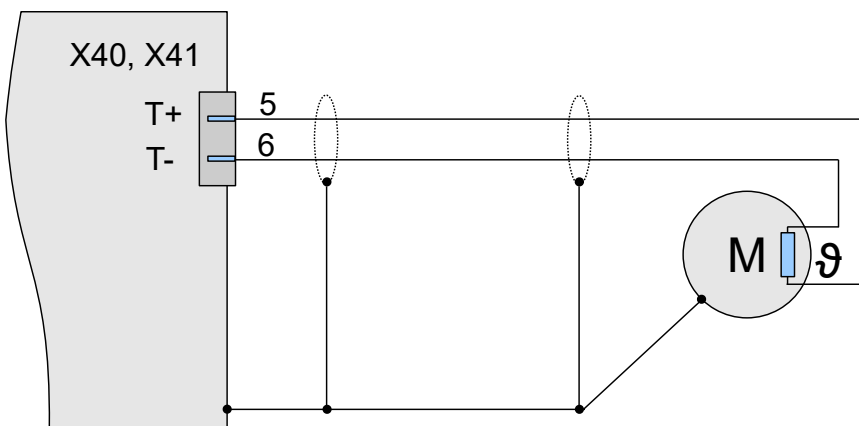

Figure 31: Motor temperature connection

Notice: The temperature measurement input is galvanically isolated from the power part of the servo drive. Therefore single insulation between motor and temperature sensor is sufficient.

7.12.3 Motor Brake

A motor brake may be connected to X40 and X41. Use X40 for axis 0 and X41 for axis 1. The connected motor brake is controlled via digital output DO1 of the corresponding axis. See chapter 7.11.2 for additional information.



Figure 32: Motor connectors

Pin Layout X40/X41	Pin	Name	Description	
	1	5		
	2	6		
	3	7	Brake +	Positive brake output
	4	8	Brake -	Negative brake output
	6	5		
	8	7		

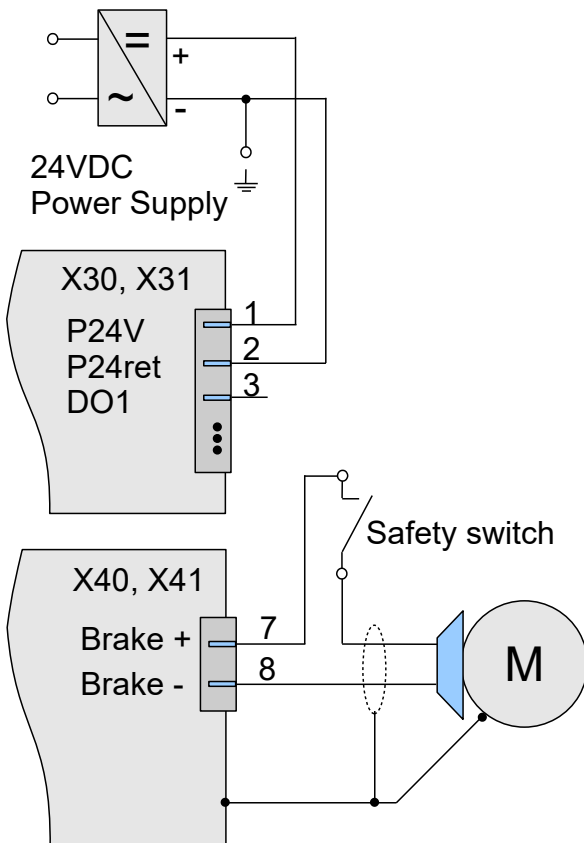

Figure 33: Typical motor brake connection with external safety switch

Warning: Do not use the digital output DO1 of connector X30 (X31) for any other function when the motor brake is connected through the connector X40 (X41).

8 Commissioning and Diagnostics

The following utilities are available for commissioning

- The *TAM System Explorer* software which is used for all commissioning and analysis work flows.
- The setup guide [2] and additional documentation on our website.
- The guides for the Beckhoff *TwinCat* Interfaces for *Tria-Link* servo drives [3] and for *EtherCAT* servo drives [4].

8.1 Status Indicators

Immediate state information is available through six bi-colored LEDs on the front side. These indicate the actual state of the drive.

- The *System Status (Sys Status)* indicator shows the overall servo drive state and faults.
- The *STO Status* indicator shows the STO state.
- The *Run Link Status* indicator shows if the fieldbus is running.
- The *Error Link Status* indicator shows if there is a connection error with the fieldbus.
- The two *Axis Status* indicators shows, if the axes are active and have no warning or error.



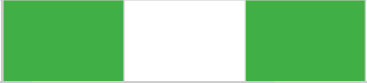

Figure 34: Status indicators

Further information on the status display can be found in the following chapters.

8.1.1 System Status Indicator

The *System Status (Sys Status)* indicator shows the overall status of the servo drive. Errors and warnings from *STO Status and Link Status* are passed to the *System Status* indicator. However, warnings or errors on *Axis Status* are not displayed with this indicator.

The system status indicator can show three different status levels. The following table shows how the status level is related to the signalling of the indicator.

Status Level	Signalling	Description
Normal Operation		Flashing green. No warning or error. However, warning or errors on Axis Status are not displayed here.
Warning		Flashing red. Warning affecting the whole servo drive or warning from other status indicators.
Error		Flashing red. Error affecting the whole servo drive or error from other status indicators.

Warnings on the System Status indicator can have various reasons.



- Warnings indicated from *STO Status*
- Warnings indicated from *Link Status*
- Bridge voltage out of range
- etc.

Errors on the System Status indicator can have various reasons.

- Errors indicated from *STO Status*
- Temperature limit
- etc.

8.1.2 STO Status

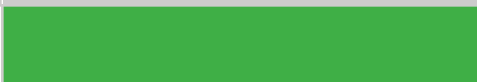
The *STO Status* indicator can show three different status levels. The following table shows how the status level is related to the signalling of the indicator.

Status Level	Signalling	Description
Normal Operation		Steady green. No warning or error.
Warning		Flashing red. <i>STO</i> Active State.
Error		Flashing red. <i>STO</i> Inconsistent, <i>STO</i> Pulse-test failed, other <i>STO</i> related errors.

8.1.3 Run and Error Link Status

The *Run* and *Error Link Status* indicator shows information about the fieldbus status. The signalling of the two fieldbuses is not the same and is described in more detail in the following chapters.

8.1.3.1 *Tria-Link*

If no link is used the servo drive can be configured in stand-alone mode. This has the effect, that both indicators are off. However, if *Tria-Link* is used, the indicators behave as described below.

Run Link Status Indicator

Status Level	Signalling	Description
Normal Operation		Steady green. Link is up and has no errors or warnings.

Error Link Status Indicator



Status Level	Signalling	Description
Error		Steady red. Link is down. Cable is not plugged, etc.

8.1.3.2 *EtherCAT*

The *Run Link* and *Error Link* indicators comply with the official specification of *EtherCAT* Technology Group.

8.1.4 Axis Status Indicator

The two Axis Status indicators shows the state of the two axes. These indicators can show three different status levels. The following table shows how the status level is related to the signalling of the indicator. Note that, errors from *STO Status* and *Sys Status* are passed to this indicator.

Status Level	Signalling	Description
Normal Operation		Steady green. Axis is enabled and in normal operation.
Warning		Flashing red.
Error		Flashing red. Position error, over-current, errors from the other status indicators, etc.

9 Appendix

9.1 Warranty Information

The products covered in this manual are warranted to be free of defects in material and workmanship and conform to the specifications stated either within this document or in the product catalog description. All Triamec Motion AG products are warranted for a period of 12 months from the time of installation, or 18 months from time of shipment, whichever comes first. No other warranties, expressed or implied – and including a warranty of merchantability and fitness for a particular purpose – extend beyond this warranty.

9.2 Service

We are committed to quality customer service. In order to serve in the most effective way, please contact the Customer Support at Triamec Motion AG for assistance.

Triamec Motion AG

Lindenstrasse 16

CH-6340 Baar

Switzerland

Phone: +41-41-747 4040

E-mail: support@triamec.com

Web: www.triamec.com

References

The documents referenced in this manual

- [1] "TP50-TP350 Power Supplies Hardware Manual",
HWTP50-TP350_E_HardwareManual_EP009.pdf, Triamec Motion AG, 2022
- [2] "Servo Drive Setup Guide",
ServoDrive-SetupGuide_EP018.pdf, Triamec Motion AG, 2022
- [3] "TwinCAT: Tria-Link Setup Guide",
SWTC_TwinCAT-UserGuide_EP027.pdf, Triamec Motion AG, 2022
- [4] "TwinCAT: EtherCAT Setup Guide",
SWTC_TwinCAT-UserGuideEcat_EP009, Triamec Motion AG, 2022
- [5] "Option Modules Manual",
HWTO_OptionModulesManual_EP013.pdf, Triamec Motion AG, 2022
- [6] "Ethernet Interface",
AN123_Ethernet_EP004.pdf, Triamec Motion AG, 2022
- [7] "Grounding Instructions",
AN144_GroundingInstructions_EP002.pdf, Triamec Motion AG, 2022

Glossary

Abbrev	Meaning
CE	CE marking
EMC	Electromagnetic compatibility
FET	Field effect transistor
GND	Ground
IEC	International Electrotechnical Commission
ISO	International Organization for Standardization
LED	Light-emitting diode
PELV	Protective Extra Low Voltage
PL	Performance Level
PWM	Pulse-width modulation
RJ-45	Standardized network interface found on Ethernet or network cables
SIL	Safety Integrity Level
STO	Safe torque off
SVM	Space vector modulation
TAM System Explorer	Tool for commissioning, analysis and optimization of a TAM system
TM	Triamec Motion AG
TN-C-S	Terre neutre combiné séparé
TwinCAT	Beckhoff automation software
V _{AC}	AC voltage
V _{DC}	DC voltage
VDE	Verband der Elektrotechnik, Society of German Electrical Technicians

Revision History

Version	Date	Editor	Comment
001	2023-07-07	re, ab	First release for <i>TSD350 Rev. 2</i> , based on manual of <i>TSD350 Rev. 0-1</i>
002	2023-09-14	sm	Add timing of fast inputs with minor restructuring
003	2024-02-08	ab	Changed connector designation to Mating Connector Type, correct formatting
004	2024-04-18	ab, bl	Add 'TTL Inputs Connection' description, clarified chapter 7.10.4

Copyright © 2024
Triamec Motion AG
All rights reserved.

Triamec Motion AG
Lindenstrasse 16
6340 Baar / Switzerland

Phone +41 41 747 4040
Email info@triamec.com
Web www.triamec.com

Disclaimer

This document is delivered subject to the following conditions and restrictions:

- This document contains proprietary information belonging to Triamec Motion AG. Such information is supplied solely for the purpose of assisting users of Triamec products.
- The text and graphics included in this manual are for the purpose of illustration and reference only. The specifications on which they are based are subject to change without notice.
- Information in this document is subject to change without notice.